

E50/100/150/200-H

HIGH VOLTAGE BATTERY

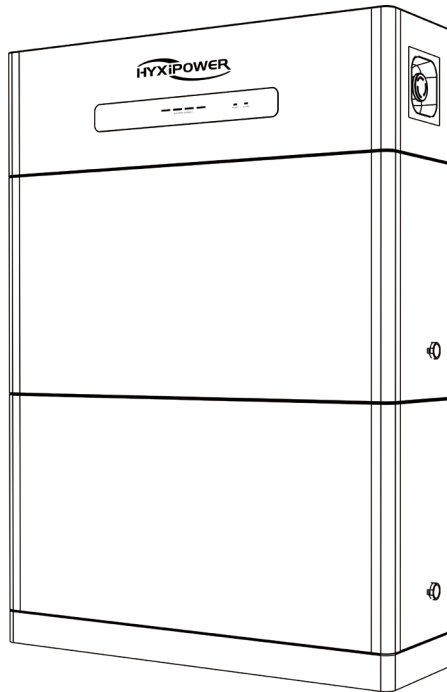

Carefully read this battery system user instructions before using.
Read and save these instructions.



© 2024 ZHEJIANG HYXI TECHNOLOGY CO., LTD. All rights reserved.

This document cannot be copied fully or partially, transferred, or distributed in any form without the prior written permission of ZHEJIANG HYXI TECHNOLOGY CO., LTD (hereinafter referred to as "HYXiPOWER").

TRADEMARKS



and other HYXiPOWER trademarks are the trademarks or registered trademarks of HYXiPOWER All other trademarks mentioned herein are the properties of their respective owners.

- 1. Product Introduction..... 1**
 - 1.1 Scope of Application.....1
 - 1.2 Overview of Product Naming Rules.....1
- 2. Safety Instructions2**
 - 2.1 Interpretation of The Logo2
 - 2.2 Precautions/Environmental Requirements2
 - 2.3 Risk Factors.....3
 - 2.4 Response to Emergency Situations.....3
 - 2.5 Notes.....4
 - 2.6 Personnel Requirements4
- 3. Limitation of liability..... 6**
- 4. Installation.....7**
 - 4.1 Installation packing list of BDU7
 - 4.2 List of Operating Tools.....7
 - 4.3 Location and environmental requirements8
 - 4.4 Product installation instructions8
 - 4.4.1 Installation space requirements8
 - 4.4.2 Precautions.....9
 - 4.5 Product appearance diagram.....10
 - 4.5.1 Overall appearance diagram.....10
 - 4.5.2 BDU Appearance Schematic11
 - 4.5.3 Schematic Diagram of Battery PACK Module Appearance11
 - 4.5.4 Installation holes on the floor.....12
 - 4.6 Installation steps on the floor12
- 5. Electrical & Com. Connection.....16**
 - 5.1 Electrical and Communication Interfaces16
 - 5.1.1 Communication Interface (COM.)16
 - 5.1.2 Communication Interface (CAN)16
 - 5.1.3 Power Button.....17
 - 5.1.4 High-voltage Power-up Button.....17
 - 5.1.5 Power Interface17
 - 5.2 Electrical Connection.....18

- 5.2.1 Grounding procedure.....18
- 5.2.2 PACK-PACK.....18
- 5.2.2 PACK-BDU.....19
- 5.2.3 PACK-BASE.....20
- 5.2.4 BDU-PCS.....21
- 5.2.5 Switch on when system connected.....22
- 6. LED indicator description.....23**
 - 6.1 LED display and system status.....23
 - 6.2 SOC lamp and capacity correspondence.....23
- 7. Battery System Startup and Shutdown Procedure.....24**
- 8. Online monitoring25**
- 9. Routine Maintenance.....26**
 - 9.1 Routine maintenance.....26
 - 9.2 General Troubleshooting26
 - 9.3 Storage Requirements:.....27
 - 9.4 Alarm Description.....27
- 10. Appendix.....29**
 - 10.1 Technical Parameter.....29
 - 10.2 Contact Information.....30

1. Product Introduction

1.1 Scope of Application

This manual is intended for the following devices:

- HYX-EBDU-H
- HYX-E50B-H
- HYX-E50-H
- HYX-E100-H
- HYX-E150-H
- HYX-E200-H



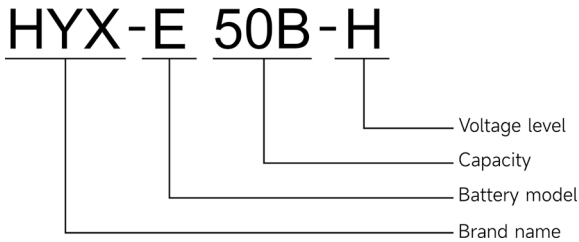







1.2 Overview of Product Naming Rules



Hyxi energy storage high voltage stacker can provide a variety of operating modes according to different needs, self-generation, peak-shaving, battery priority, etc.

2. Safety Instructions

2.1 Interpretation of The Logo

Symbol	Description
	There are potential hazards when the equipment is in operation, so please take precautions when operating the equipment.
	High voltage exists when the equipment is in operation, so when operating the equipment, make sure the equipment is powered off.
	The equipment should be kept away from open flames or sources of ignition.
	At the end of the equipment's life, do not dispose of it with household waste.
	Beware of fire.
	Before operating the equipment, please read the product manual in detail.
	Equipment should be kept away from areas accessible to children.
	Please use the equipment reasonably, extreme conditions of use, the equipment has the risk of explosion.
	Observe enclosed documentation.
	Protective gloves must be worn.
	CE certification mark.

2.2 Precautions/Environmental Requirements

When installing, operating and maintaining the equipment, please read this manual and follow all safety precautions marked on the equipment and in the manual.

The "NOTICE", "CAUTION", "WARNING" and "DANGER" items in this manual do not represent all safety items to be observed. They are in addition to all safety precautions. HYXiPOWER shall not be liable for any violation of the general safety requirements or for any violation of the safety standards for the design, manufacture and use of the equipment.

The equipment should be used in an environment that conforms to the design specifications; otherwise, equipment failure may result, and the resulting abnormal functioning of the equipment or damage to components, personal safety accidents, and property damage are not covered by the equipment warranty.

Local laws, regulations and codes should be observed when installing, operating and maintaining the equipment. The safety precautions in the manual are intended only as a supplement to local laws and regulations and norms.

Lifting or lowering the system carries the risk of injury. The battery is heavy. There is a risk of injury if the battery is not lifted or dropped properly during transport or during installation or removal. Two or more people must lift and transport the battery.

2.3 Risk Factors

Risks of Explosion:

- Do not subject the battery module to heavy impacts;
- Do not crush or puncture the battery module;
- Do not dispose of the battery module in a fire.

Risks of Fire:

- Do not expose the battery module to temperature exceeding 140° F (6° C);
- Do not place the battery module near a heat source, such as a fireplace;
- Do not expose the battery module to direct sunlight;
- Do not allow the battery connectors to touch conductive objects such as wires.

Risks of Electric Shock:

- Do not disassemble the battery module;
- Do not touch the battery module with wet hands;
- Do not expose the battery module to moisture or liquids;
- Keep the battery module away from children and animals.

Risks of Damage to The Battery Module:

- Do not expose the battery module to liquids;
- Do not subject the battery module to high pressures;
- Do not place any objects on top of the battery module;
- It shall be protected from the sun and rain.

2.4 Response to Emergency Situations

Leaking Batteries

In case the leakage of electrolyte solution occurs, please avoid direct contact with the electrolyte solution and the gas that may be generated by it. Direct contact may lead to skin irritation or chemical burns. If the user comes into contact with the electrolyte solution, please do as follows:

Accidental Inhalation of Harmful Substances:

Evacuate from the contaminated area, and seek medical attention immediately.

Eye Contact:

Rinse eyes with flowing water for 15 minutes, and seek medical attention immediately.

Dermal Contact:

Wash the affected area thoroughly with soap and water, and seek medical attention immediately.

Ingestion:

Induce vomiting, and seek medical attention immediately.

Fire:

Please keep a Class ABC fire extinguisher or a carbon dioxide extinguisher near the equipment.



If a fire breaks out where the battery module is installed, please do as follows:

- Extinguish the fire before the battery module catches fire;
- If the battery module catches fire, please do not try to put out the fire, and evacuate immediately.

Wet Batteries and Damaged Batteries

- Do not touch the battery module after being wet from and soaked in the water.
- Do not use the battery module if it is damaged. Otherwise, the loss to life and property will be caused.
- Please pack the battery in its original packaging, and return it to our company or the distributor.

2.5 Notes

The operation of transportation, turnover, installation, wiring and maintenance shall meet the laws, regulations and related standards of the country and region where it is located.

The user's own materials and tools required for operation must meet the laws and regulations and related standards of the country or region where they are located.

Permission must be obtained from the power department of the country or region in which the system is located before it can be connected to the grid.

You should be fully familiar with the composition and working principle of the whole grid-connected photovoltaic power generation system and the relevant standards of the country/region where the project is located.

Reverse engineering, decompiling, disassembling, adapting, implanting or other derivative operations of the equipment software are prohibited. It is not allowed to study the internal implementation of the equipment, obtain the source code of the equipment software, steal intellectual property rights, etc. in any way, nor shall the results of any equipment software performance test be disclosed.

2.6 Personnel Requirements

Personnel responsible for the installation and maintenance of Hyxi equipment must first be strictly trained to understand various safety precautions and master the correct operation methods.

Only qualified professionals or trained personnel are allowed to install, operate and maintain the equipment.

Only qualified professionals are allowed to remove safety facilities and overhaul equipment.

Personnel who operate the equipment, including operators, trained personnel, and professionals should have the local state required special operating qualifications, such as high voltage operation, ascent, and special equipment operation qualifications.

Replacement of equipment or parts (including software) must be done by professionals or authorized personnel.

Description:

- Professional personnel: People who have training or experience in operating equipment and can clearly understand the various potential sources and magnitudes of hazards during equipment installation, operation, and maintenance.
- Trained personnel: A person who has received the appropriate technical training and has the necessary experience to be aware of the hazards that may be presented to him when performing a particular operation and to take measures to minimize the hazards to himself or to other personnel.
- Operator: A person, other than a trained person or a professional, who may come into contact with the equipment.









3. Limitation of liability

Hyxi is not responsible in the event of any of the following

- It does not operate in the conditions of use described in this manual.
- The installation and use environment does not comply with the provisions of the relevant international or national or regional standards.
- Unauthorized disassembly, modification of the product or modification of the software code.
- Failure to follow the operating instructions and safety warnings in the product and documentation.
- Equipment damage caused by abnormal natural environment (force majeure, such as earthquake, fire, windstorm, flood, mudslide, etc.).
- Damage to equipment caused by abnormal natural environment (force majeure, such as earthquake, fire, storm, flood, mudslide, etc.)
- Transportation damage caused by the customer's own transportation.
- Damage caused by storage conditions that do not meet the requirements of the product documentation.
- Damage to the hardware or data of the equipment due to customer negligence, improper operation or intentional damage.
- Damage to the system caused by a third party or the customer, including damage caused by handling and installation that does not meet the requirements of this manual, and damage caused by adjustments, alterations, or removal of identification marks that do not meet the requirements of this manual.

4. Installation













4.1 Installation packing list of BDU

No.	Accessories	Model	Quantity
1		Anti-tilting bracket	1
2		Wall Mount Tie Rods	1
3		M6-50 hexagonal flange face expansion bolts	2
4		M5-8 Phillips countersunk head screws	4 located at the bottom of the BDU
5		M6 nuts	2
6		M4-20 anti-theft screws	2
7		Ethernet cable(1m)	1
8		High voltage cable (HV-)	1
9		High voltage cable (HV+)	1

*Description: PACK without accessories.

4.2 List of Operating Tools

For example, protective gear that users need to prepare when installing the product.

					
Impact Drill	Socket wrenches	Torque wrench	Torque screwdriver	Marker	Measuring tape
					
Horizontal ruler	Vacuum cleaner	Protective gloves	Goggles	Dust mask	Insulated shoes

4.3 Location and environmental requirements

The battery enclosure has an IP65 protection rating and shall be installed indoors.

The battery has no ventilation requirements.

The battery housing should be installed in a location free from the risk of water (standing water, submersion, etc.). The installation location must be well drained.

The product needs to be installed on a level surface.

The following places are not allowed to be installed:

- In environments where the temperature is less than -20°C or more than 50°C .
- Places where humidity and condensation exceed 95%.
- Places where salt and humid air can penetrate.
- Flooded areas.
- Earthquake areas - additional safety measures are required here.
- Locations at altitudes above 2000 meters.
- Explosive atmospheres.
- Locations with prolonged exposure to sunlight.
- Places where the ambient temperature changes drastically.
- Humid rooms.
- Locations with highly flammable materials or gases.
- Locations with a potentially explosive atmosphere.

When multiple PACKs form a battery system:

1. If the factory date of each PACK \leq 3 months, it can be used directly to form a system

The 6th and 7th digits of SN represent the year, and the 8th and 9th digits represent the number of weeks. E.g. 2421 represents the 21st week of 2024.

D1	D2	D3	D4	D5	D6	D7	D8	D9	D10	D11	D12	D13	D14
----	----	----	----	----	----	----	----	----	-----	-----	-----	-----	-----



2. If the factory date of each PACK $>$ 3 months, it is recommended to fully charge each PACK separately before forming a system

Because of the same charging and discharging characteristics of the series system, the imbalance problem can only occur before the formation of the system; After the formation of the system, all the PACKs are charged and discharged at the same time with the exact same amount of power, so there will be no imbalance problem.

4.4 Product installation instructions

4.4.1 Installation space requirements

Installation angle

The product supports installation on the ground and with the anti-tilting device, do not tilt the product forward, horizontal, upside down, backward and sideways installation.

Installation position

If you choose other types of walls and floors, the walls and floors should meet the load-bearing requirements of the equipment, and the walls and floors where the installation is located should have fire retardant properties.

Installation space

When installing this product, make sure there is no other equipment (except for the installation of necessary equipment, masking devices) and flammable and explosive materials around, and reserve sufficient installation space as shown in the following figure (for example, the highest stacking method of this product) to ensure installation, heat dissipation, safety and other needs.

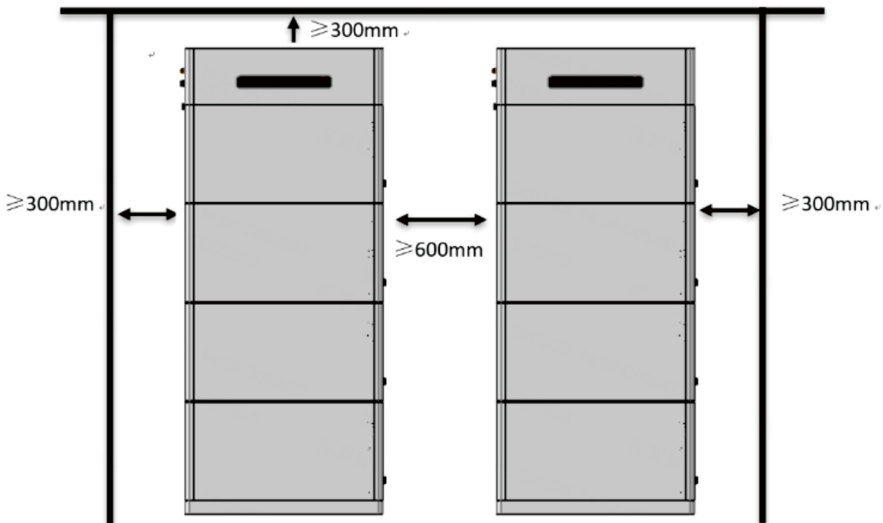

4.4.2 Precautions

The battery are heavy. There is a risk of injury if the battery is not lifted or dropped properly during transportation or during installation or removal.

Two or more people must lift and transport the inverter and battery.

When wiring the battery, it must be well protected, one person should wire and one person should supervise and check to prevent the battery short circuit accident.

The electrical connection must be complete and firm, and the installation position and direction of the CT on the grid side must be correct (the direction of the arrow of the CT faces the grid side), otherwise the current will not be detected; in addition, if you need to realize the backflow prevention, the CT should be installed on the main road of the grid.

The installer should wear protective equipment.

4.5 Product appearance diagram

4.5.1 Overall appearance diagram

No.	Description
1	Battery energy distribution unit (BDU)
2	BDU emergency stop switch
3	BDU display panel
4	Battery PACK module
5	Base
6	Explosion-proof valve

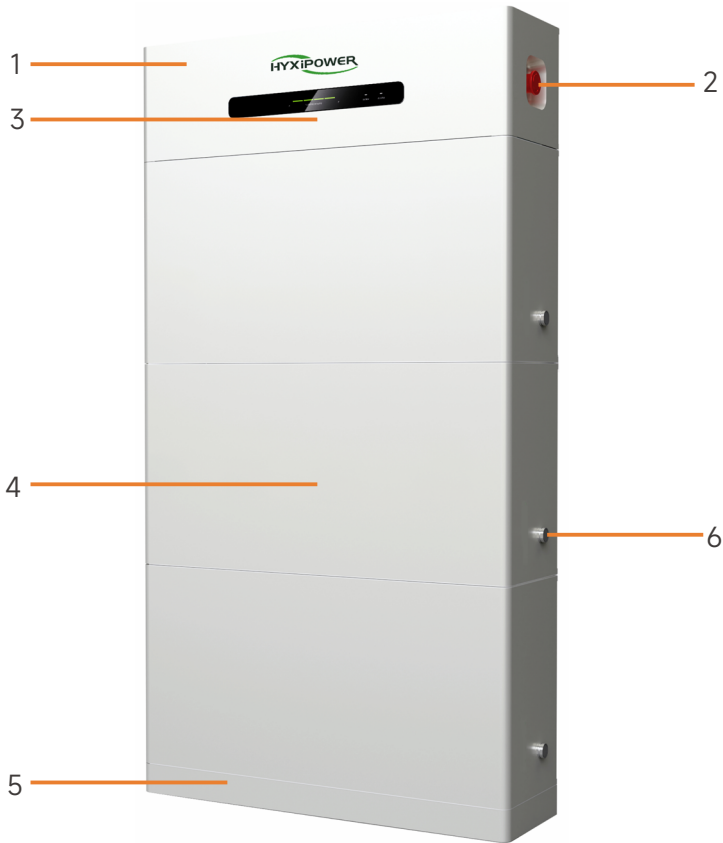

4.5.2 BDU Appearance Schematic

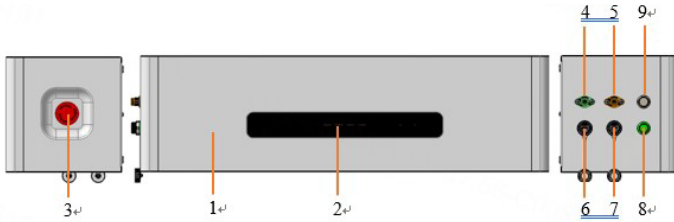

No.	Description
1	Battery energy distribution unit (BDU)
2	BDU display panel
3	BDU emergency stop switch
4	High-voltage negative socket
5	High-voltage positive socket
6	Debug
7	Inverter connection socket
8	High voltage power button
9	12V low voltage power button

4.5.3 Schematic Diagram of Battery PACK Module Appearance

The standard capacity of a single PACK is 5kWh.

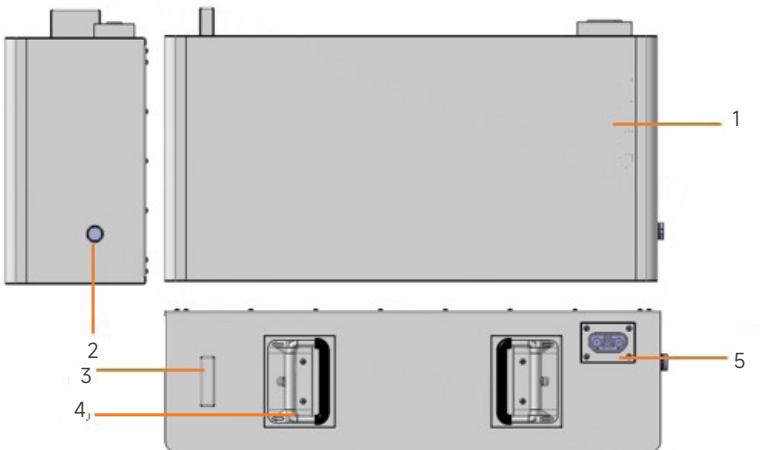

No.	Description
1	Battery PACK module
2	PACK explosion-proof valve
3	Installation positioning block
4	PACK puller
5	High voltage/communication connector (one on top and one on bottom)

4.5.4 Installation holes on the floor

The dimensions of the installation holes for the floor-mounted anti-tip structure of this product (taking the highest stacking method of this product as an example):

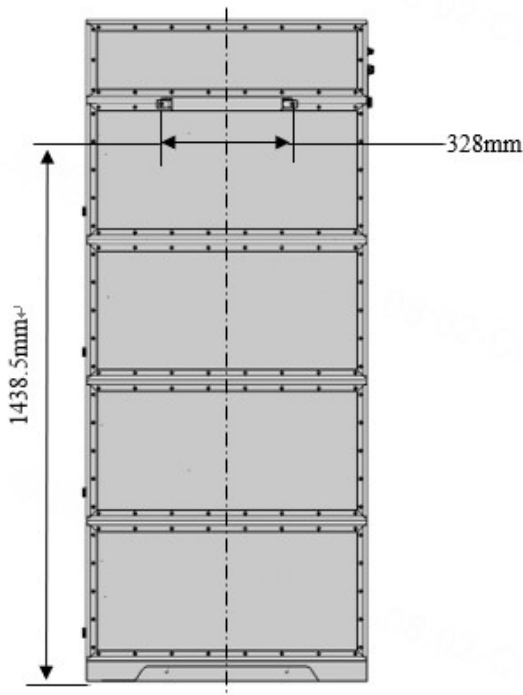

4.6 Installation steps on the floor

Step 1: Wall drilling and installation of wall ties, after selecting a suitable installation site and reserving sufficient installation space, use a tape measure and with the level of the vertical wall to mark a good hole, use an impact drill to drill a fixed hole of 10mm diameter, the depth of the hole is at least 50mm, the expansion screw into the hole, the wall ties on one side of the wall will be installed and locked in the wall.

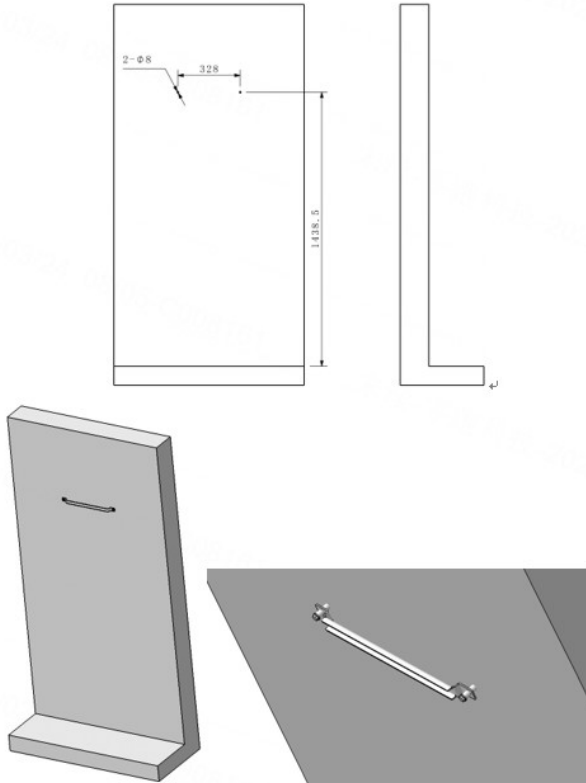

Step 2: Ground the base.

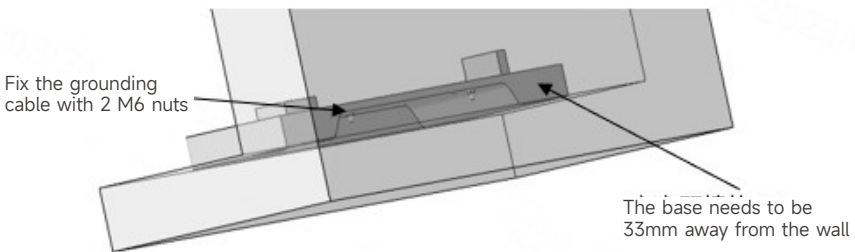

Step 3: PACK stacking, according to the installation position of the wall-mounted ties, with the help of a horizontal ruler and marker to determine the placement of the base, PACK stacking in turn to ensure accurate positioning, tightly connected, before and after stacking.

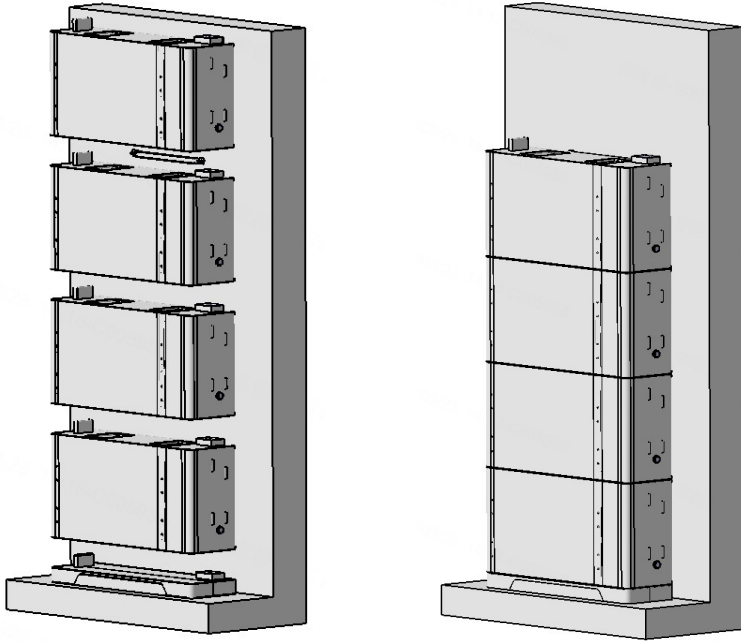

Step 4: BDU installation anti-tip bracket, the anti-tip bracket through four M5-8 countersunk head screws fixed in the bottom of the BDU, while paying attention to the installation direction of the anti-tip bracket, the normal installation, the outer flip side of the bracket towards the bottom.

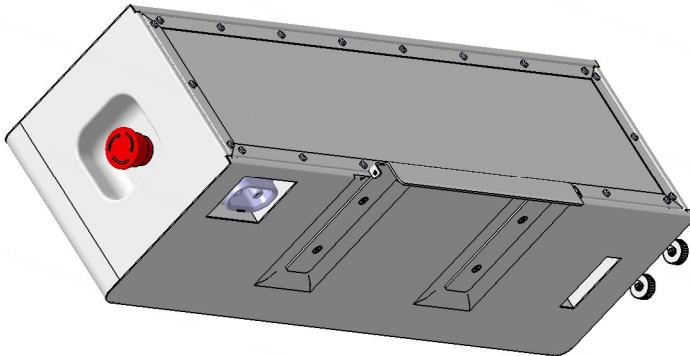

Step 5: BDU stacking and hanging anti-toppling device, the BDU installed anti-toppling bracket stacked on the PACK in step 3, to ensure accurate positioning, tightly connected at the same time the anti-toppling bracket can be inserted into the wall ties to play the role of anti-toppling, and then lock into two M4-20 anti-theft screws, the installation is completed.

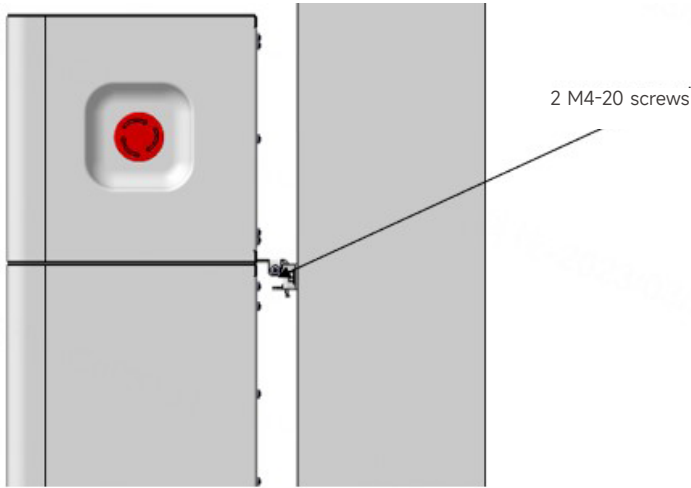
**⚠ DANGER**

- Before drilling, please make sure to avoid the pre-buried utility lines in the wall to avoid danger;
- To prevent dust from entering human respiratory tract or eyes when punching holes, personnel should wear appropriate protective gear;
- Every time you stack a PACK, you need to check the stacking position of the PACK to avoid dumping due to rapid stacking;
- Ensure that the switch is closed when stacking BDU at the end to avoid danger.

5. Electrical & Com. Connection

5.1 Electrical and Communication Interfaces

5.1.1 Communication Interface (COM.)

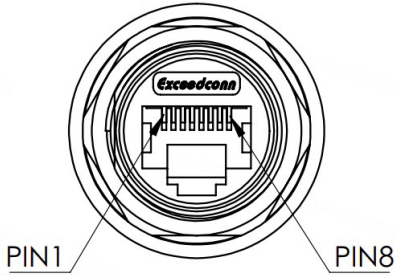

Pins	Name	Function	Connector
1	485A	Internal debugging use	RJ45
2	485B	Internal debugging use	RJ45
3	Debug_CANH	Internal debugging use	RJ45
4	Debug_CANH	Internal debugging use	RJ45
5	DO output positive	Internal debugging use	RJ45
6	DO output negative	Internal debugging use	RJ45
7	SBMU_CANH	Internal debugging use	RJ45
8	SBMU_CANL	Internal debugging use	RJ45

5.1.2 Communication Interface (CAN)

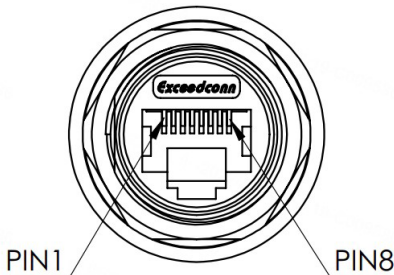

Pins	Name	Function	Connector
1	485A	Communication with inverters	RJ45
2	485B	Communication with inverters	RJ45
3	/	/	RJ45
4	CANH	Communication with inverters	RJ45
5	CANL	Communication with inverters	RJ45
6	/	/	RJ45

5.1.3 Power Button

12V



Button	Function
12V	Activate the BDU-PACK communication. Need to be switched on when system running

5.1.4 High-voltage Power-up Button

POWER



Button	Function
POWER	Activate the BDU-PACK energy flow. Need to be switched on when system Running (long press for 5s until hear “click”).

5.1.5 Power Interface

HV-

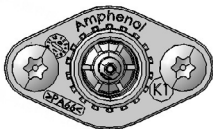

HV+



Pins	Name	Function	Remarks	Connector
1	HV-	BDU output negative	Connecting the inverter	Quick plug
2	HV+	BDU output positive	Connecting the inverter	Quick plug

5.2 Electrical Connection

5.2.1 Grounding procedure

The cross-sectional area of the secondary grounding cable must be the same as the cross-sectional area of the PE core in the AC cable.

The secondary grounding cable and terminal block are to be prepared by the customer.

- Step 1: Make the cable and crimp the terminal block.
- Step 2: Remove the screws from the grounding terminal and use a screwdriver to secure the cable.

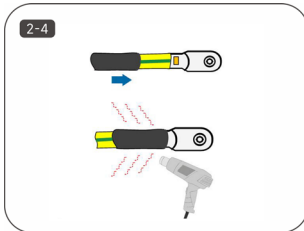
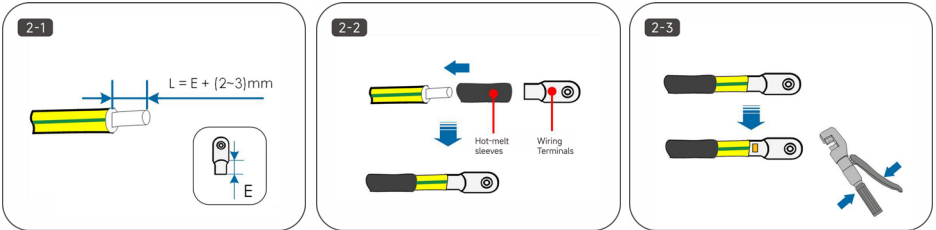

- Step 3: Apply silicone or paint to the grounding terminal to improve its corrosion resistance.
- Step 4: Use an M6 hex socket electric tool (or a manual M6 hex socket wrench) to secure the grounding wire harness to the grounding position on the base with two M6 hex flange nuts.

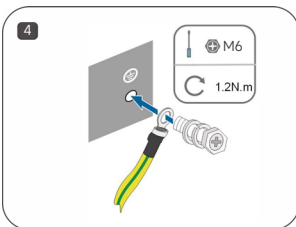

5.2.2 PACK-PACK

Pins	Name	Function
A	PACK-	Power negative connection
B	PACK+	Power positive connection
1	12V+	12V power positive connection

Pins	Name	Function
2	PE	Box equipotential connection cable
3	12V-	12V power negative connection
4	CANH	Communication CANH
5	CANL	Communication CANL
6	/	/
7	/	/
8	BAS_CANH	Communication BAS_CANH
9	BAS_CANL	Communication BAS_CANL

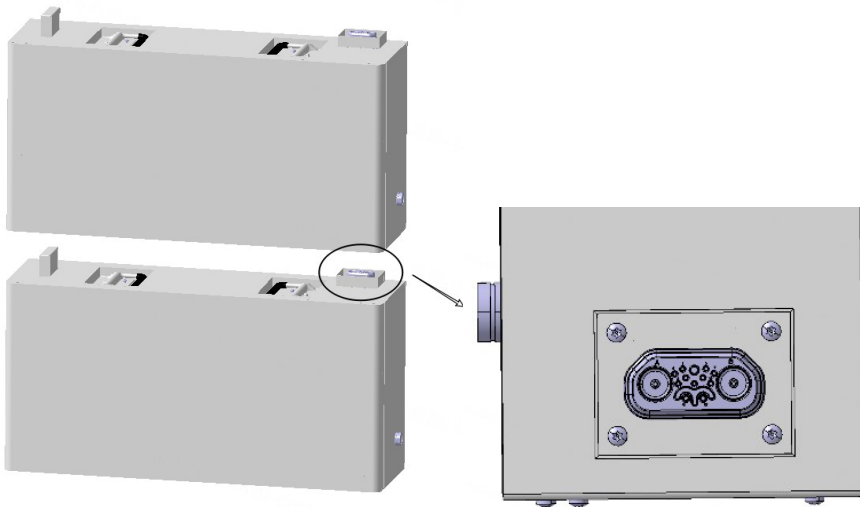

5.2.2 PACK-BDU

Pins	Name	Function
A	PACK-	Power negative connection
B	PACK+	Power positive connection
1	12V+	12V power positive connection
2	PE	Box equipotential connection cable
3	12V-	12V power negative connection
4	CANH	Communication CANH
5	CANL	Communication CANL
6	/	/

Pins	Name	Function
7	/	/
8	/	/
9	/	/
10	/	/
11	PACK+	DC input positive
12	PACK-	DC input negative



5.2.3 PACK-BASE

Pins	Name	Function
A	PACK-	Power negative connection
B	PACK+	Power positive connection
1	/	/
2	PE	Box equipotential connection cable
3	/	/
4	CANH	Communication CANH
5	CANL	Communication CANL

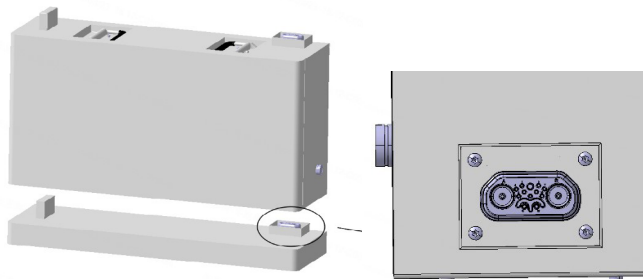

5.2.4 BDU-PCS

Making BMS Communication Cables

To ensure the normal operation of the BMS and inverter wiring before the BMS communication cable needs to be made.

The communication cables are defined as follows:

Pins	Name	Function
1	485A	Communication with inverters
2	485B	Communication with inverters
3	CANH	Communication with inverters
4	CANL	Communication with inverters
5	/	/
6	/	/

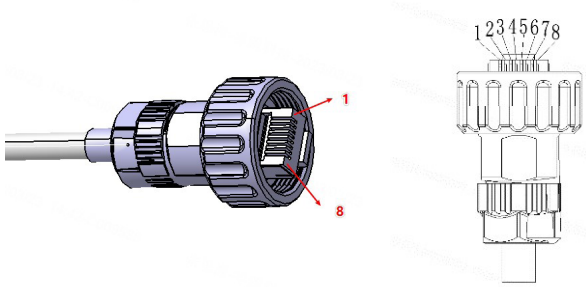

Electrical connection of BDU and inverter

- Step 1: Strip off the insulation layer of all DC cables by about 7mm.
- Step 2: Use crimping pliers to bundle the cable ends at the wiring terminals.
- Step 3: Pass the cable through the cable gland, insert the insulating sleeve and fasten it. Gently pull the cable to ensure that it is connected and fastened. Use a force of 2.5-3N·m to tighten the gland and insulating sleeve.
- Step 4: Use a multi-meter to check and confirm that the polarity of the photovoltaic string connecting cable is correct.

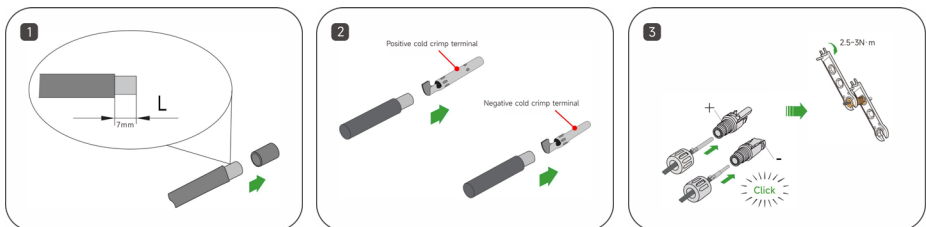

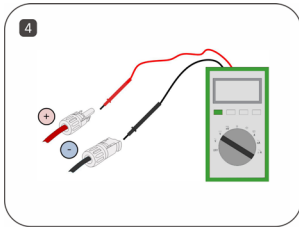

- Connect the inverter’s negative quick plug to the HV- socket of the battery BDU.
- Connect the positive quick plug of the inverter to the HV+ socket of the battery BDU;
- Connect the communication network cable of the inverter to the PCS communication interface of the battery BDU.

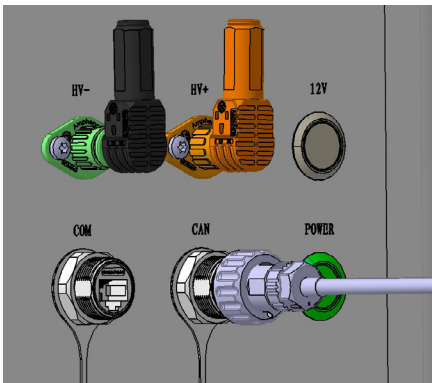

5.2.5 Switch on when system connected

When all system connections have been made, turn "12V" button and "Power" button on "Power" button need long press 5s until hear "click" in order to prevent accidental enable

Pins	Name	Function
1	HV-	High-voltage negative socket
2	HV+	High-voltage positive socket
3	12V+	Communication Switch
4	COM	Debug
5	CAN	Inverter connection socket
6	POWER	Power Switch



6. LED indicator description

6.1 LED display and system status

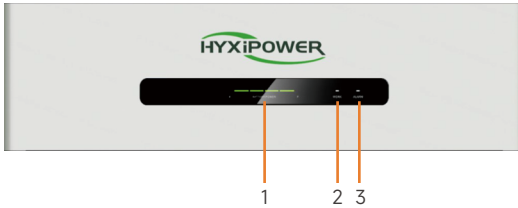

Pins	Name
1	SOC Green
2	WORK Green
3	ALARM Red

System Status	WORK	ALARM	SOC			
	●	●	●	●	●	●
Shutdown	Off	Off	Off			
Idle state	On 0.5s, off 1.5s	Off	According to the power display			
Normal operation	On	On 0.5s, off 0.5s	According to the power display			
First level alarm	On	On 0.5s, off 1.5s	According to the power display			
Second level alarm	Off	Off	According to the power display			
Third level alarm	Off	On	According to the power display			

6.2 SOC lamp and capacity correspondence

Status	Charging				Discharging			
	●	●	●	●	●	●	●	●
Capacity indicator	●	●	●	●	●	●	●	●
SOC<25%	On 0.5s, off 1.5s	Off	Off	Off	On	Off	Off	Off
25% ≤ SOC<50%	On	On 0.5s, off 1.5s	Off	Off	On	On	Off	Off
50% ≤ SOC<75%	On	On	On 0.5s, off 1.5s	Off	On	On	On	Off
75% ≤ SOC<90%	On	On	On	On 0.5s, off 1.5s	On	On	On	On
90% ≤ SOC<100%	On	On	On	On	On	On	On	On
Operation indicator	On							

7. Battery System Startup and Shutdown Procedure

Battery system startup normal process

- Press the BDU “POWER” button, both indicators of “POWER” and “ON/OFF” light up
- Long press the BDU “ON/OFF” button for more than 3s until hear “click”
- Current both LED indicators show the system is on running, all system startup complete.

Battery system shutdown process

- Long press the BDU “ON/OFF” button for more than 3s until hear “click”
- Press the BDU “POWER” button, both indicators of “POWER” and “ON/OFF” will go out
- Current all LED indicator lights are off, all system shutdown complete.

8. Online monitoring

All the battery data is uploaded to the inverter, and the monitoring is uploaded from the inverter side.

9. Routine Maintenance

9.1 Routine maintenance

- If the energy storage system is not used for more than three months, it is necessary to charge the energy storage battery to a full charge to avoid over-discharge due to self-consumption of the system.
- The battery has a discharge depth of 85%, i.e. the system stops discharging when 15% of the power SOC remains. It is recommended to charge in time.
- If the battery does not receive a charge source (from PV or GRID) for an extended period, please turn off the "12V" button. Otherwise, self-consumption may deplete the battery completely.

Product cleaning

- First, gently wipe the surface with a soft microfiber cloth to remove dust or debris.
- Moisten the cloth with water (neutral detergent can also be added) and wring out excess water.
- Wipe away any debris or dirt.
- Finally, wipe off all water from the surface with a dry microfiber cloth.

CAUTION

- The cleaning process should be carried out away from electrical connections to prevent water from getting inside the product housing, connection ports, etc.
- Do not wipe the product with reagents other than water (H₂O).

9.2 General Troubleshooting

Battery communication failure:

- Failure analysis: CAN communication or 485 communication failure.
- Solution: Check if the communication line is in good contact.

Battery over-undervoltage fault:

- Failure Analysis: Voltage range is not compatible with the battery and the battery energy is insufficient.
- Solution: Check the battery voltage, PV or whether it will be charged automatically when there is grid.

Overload fault:

- Failure Analysis: The load is too large.
- Solution: Check whether the load exceeds the machine power, all down and then part of the load up.

Output short circuit fault:

- Fault analysis: There is a short circuit working condition on the load side.
- Solution: All power down, after the power indicator goes off, check whether the load is short-

circuited, and then power up after troubleshooting.

9.3 Storage Requirements:

- Short-term storage (duration <1 month): Temperature $\leq 50^{\circ}\text{C}$
- Long-term storage (3 months): Temperature $\leq 35^{\circ}\text{C}$, battery charge state at 30%-50%
- Long-term storage (more than 6 months): Temperature $\leq 25^{\circ}\text{C}$, battery charge state at 30%-50%
- When not in use for an extended period, it is recommended to perform a standard charge and discharge maintenance on the battery every 6 months. The battery should be stored at a charge state of 30%-50%.

Note: Long-term storage can lead to irreversible loss of battery capacity. For example, according to CN national standards, a battery stored at 45°C with 50% state of charge (SOC) for 28 days should have a capacity recovery rate of $>94\%$.

It is recommended to fully charge each battery pack to 100% SOC before installing a new system or expanding energy capacity, and then proceed with the installation or expansion.

SOC Handling:

Occasional SOC fluctuation are considered normal and do not affect the normal operation of the system. If SOC fluctuates frequently, please contact the installer or manufacturer.

It is recommended to fully charge each battery pack to 100% SOC before installation or energy expansion for a new system. Then proceed with installation or expansion.

9.4 Alarm Description





The following alarms are recoverable alarms, please refer to the following table to process and

Fault name	Action	Recovery conditions
Battery discharge overcurrent	Prohibition of discharge / high voltage relay disconnection	1. Turn off part of the load 2. Reboot the device
Battery charging overcurrent	Prohibition of charge / high voltage relay disconnection	1. Restart the device 2. Contact Hyxi after-sales staff to solve
Battery charging over-voltage	Prohibition of charge/ high voltage relay disconnection	1. Restart the device 2. Contact Hyxi after-sales staff to solve the problem
Battery discharge undervoltage	Prohibition of discharge / high voltage relay disconnection	1. Restart the device 2. Contact Hyxi after-sales staff to solve the problem
Battery discharge high temperature	Prohibition of discharge / high voltage relay disconnection	1. Turn off the load of the equipment, and leave it until the battery temperature is less than 40°C 2. Contact Hyxi after-sales personnel to solve
Battery charging high temperature	Prohibition of charge / high voltage relay disconnection	1. Leave the battery temperature less than 40°C 2. Contact Hyxi after-sales personnel to solve
Battery discharging low temperature	Prohibition of discharge / high voltage relay disconnection	1. Leave to wait for the battery temperature is greater than 2°C 2. Contact Hyxi after-sales personnel to solve

Excessive battery temperature difference	Prohibition of discharge and charge / high voltage relay disconnection	<ol style="list-style-type: none"> 1. Leave the battery temperature difference less than 4°C 2. Contact Hyxi after-sales personnel to solve
Loss of communication with PCS	High Voltage Relay Disconnection	<ol style="list-style-type: none"> 1. Check the connection between BDU and PCS harness 2. Contact Hyxi after-sales staff to solve the problem
Tandem cascade communication lost	High Voltage Relay Disconnection	Contact Hyxi after-sales personnel to solve
Battery pack communication lost	High Voltage Relay Disconnection	<ol style="list-style-type: none"> 1. Check the connection between BDU and battery pack harness 2. Contact Hyxi after-sales staff to solve the problem
Smoke sensor communication lost	High Voltage Relay Disconnection	Contact Hyxi after-sales personnel to solve
BDU overtemperature	Prohibition of charging and discharging / high voltage relay disconnection	<ol style="list-style-type: none"> 1. Leave to BDU temperature less than 70°C 2. Contact Hyxi after-sales personnel to solve
Current collection sensor overtemperature	Prohibition of charging and discharging / high voltage relay disconnection	<ol style="list-style-type: none"> 1. Leave the sensor temperature less than 70°C 2. Contact Hyxi after-sales staff to solve
BDU main positive relay failure	Prohibit high voltage/ Prohibit charging and discharging/ Disconnecting high voltage relay	Contact Hyxi after-sales staff to solve
BDU main positive relay failure	Prohibit high voltage/ Prohibit charging and discharging/ Disconnecting high voltage relay	Contact Hyxi after-sales staff to solve
Pre-charge fault	Prohibit high voltage	<ol style="list-style-type: none"> 1. Restart the device 2. Contact Hyxi after-sales staff to solve the problem
BMS self-test fault	Prohibit high voltage	<ol style="list-style-type: none"> 1. Restart the device 2. Contact Hyxi after-sales staff to solve the problem
Battery temperature detection sensor failure	Prohibit high voltage/ Prohibit charging and discharging/ Disconnecting high voltage relay	<ol style="list-style-type: none"> 1. Restart the device 2. Contact Hyxi after-sales staff to solve the problem
Cell voltage sampling line failure	Prohibit high voltage/ Prohibit charging and discharging/ Disconnecting high voltage relay	<ol style="list-style-type: none"> 1. Restart the device 2. Contact Hyxi after-sales staff to solve the problem
Low insulation resistance of BDU	Prohibit high voltage	<ol style="list-style-type: none"> 1. Restart the device 2. Contact Hyxi after-sales staff to solve the problem

10. Appendix

10.1 Technical Parameter

Battery System	HYX-E50-H	HYX-E100-H	HYX-E150-H	HYX-E200-H
Module Number	 1 Module	 2 Modules	 3 Modules	 4 Modules
Nominal Battery Energy (kWh)	5.3	10.6	15.9	21.2
Available Energy (kWh)	4.5	9.0	13.5	18.0
Nominal Voltage (V)	102.4	204.8	307.2	409.6
Working Voltage (V)	86.4 ~ 115.2	172.8 ~ 230.4	259.2 ~ 345.6	345.6 ~ 460.8
Rated Output Power(kW)	3.0	6.0	9.0	12.0
Cell Type	LFP			
Max. Charging/Discharging Current (A)	35			
SOC Indicator	4*LED (25%, 50%, 75%, 100%)			
State Indicator	2*LED (work, alarm)			
Communication	CAN, RS485			
Working Temperature (°C)	0 ~ 50 (heating version-20 ~ 50)			
Ingress Protection Rating	IP65			
Working Humidity (RH)	5 ~ 95%			
Working Altitude (m)	4,000			
Warranty	10 years or > 6,000 (70%EOL)			
Dimension (W*H*D, mm)	700*600*200	700*950*200	700*1300*200	700*1650*200
Net Weight (kg)	65	115	165	215
Alarms	Over charge / Over discharge/Over current / Over temperature / Short Circuit			

10.2 Contact Information

If you have any questions about this product, please contact us.

In order to provide you with faster and better after-sales service, we need your assistance in providing the following information.

- Equipment model: _____

- Serial number of the device: _____

- Fault code / name: _____

- A brief description of the fault phenomenon: _____

UM_HYX-E(50-200)-H_V1.4-202411_EN

The manual is subject to change without notice while the product is being improved.



Zhejiang Hyxi Technology Co., Ltd.

Room 216, Block A, Building 1, No. 57 Jiang'er Road, Changhe Street,

Binjiang District, Hangzhou, Zhejiang Province, China

www.hyxipower.com

support@hyxipower.com